



Consiglio
Nazionale delle
Ricerche



MINISTERO POLITICHE AGRICOLE
ALIMENTARI E FORESTALI



MINISTERO DELL'AMBIENTE
E DELLA TUTELA DEL TERRITORIO E DEL MARE



Ministero della Salute

Controllo biologico delle piante infestanti in agricoltura e negli ambienti naturali

**M. Cristofaro, S. Arnone,
and M. Vurro**

ENEA-UTAGRI-ECO & CNR-ISPA

Roma, 14 aprile 2015

Convegno "Piano di azione nazionale per l'uso sostenibile dei prodotti fitosanitari: coordinamento, ricerca e innovazione"

Cosa rende una pianta invasiva?

- "Tutte le sostanze possono essere velenose. E' solo una questione di dose..."

(Paracelsus; 1493-1541)

(<http://learn.caim.yale.edu/chemsafe/references/>)

Cosa rende una pianta invasiva?

- "Tutte le sostanze possono essere velenose. E' solo una questione di dose..."

(Paracelsus; 1493-1541)

- Tutte le piante (aliene) possono divenire infestanti: è l'habitat che crea la differenza...

INFESTANTI: Agricoltura



Roma, 14 aprile 2015

Convegno "Piano di azione nazionale per l'uso sostenibile dei prodotti fitosanitari: coordinamento, ricerca e innovazione"

INFESTANTI: Agricoltura



Roma, 14 aprile 2015

Convegno "Piano di azione nazionale per l'uso sostenibile dei prodotti fitosanitari: coordinamento, ricerca e innovazione"

INFESTANTI: Ambienti Naturali



Roma, 14 aprile 2015

Convegno "Piano di azione nazionale per l'uso sostenibile dei prodotti fitosanitari: coordinamento, ricerca e innovazione"

INFESTANTI: Ambienti Naturali



Roma, 14 aprile 2015

Convegno "Piano di azione nazionale per l'uso sostenibile dei prodotti fitosanitari: coordinamento, ricerca e innovazione"

INFESTANTI: Ambiente Antropico



<http://peakoil.com/consumption>

Roma, 14 aprile 2015

Convegno "Piano di azione nazionale per l'uso sostenibile dei prodotti fitosanitari: coordinamento, ricerca e innovazione"

INFESTANTI: Ambiente Antropico



Roma, 14 aprile 2015

Convegno "Piano di azione nazionale per l'uso sostenibile dei prodotti fitosanitari: coordinamento, ricerca e innovazione"

INFESTANTI: Ambiente Antropico



INFESTANTI: Ambiente Antropico



<http://ragweed.eu>



INFESTANTI: Ambiente Antropico



<http://ragweed.eu>



**PIANTA
INFESTANTE**



Aree Agricole

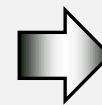

**Erbicidi o
altri sistemi**



Ambienti Naturali e/o Antropici



**rilascio di nemici naturali
dell' infestante al fine di mantenere
la densità di popolazione della pianta
al di sotto della soglia di danno**

- inquinamento ambientale
- costo economico troppo elevato

Controllo Biologico: Programma Time-Dependent

If plants become weeds, is biocontrol the right answer?

Risk of Adverse Effects
 Impact analysis: realised non-target effects
 Only four agents had Moderate, Major or Massive adverse impact on plant reproduction

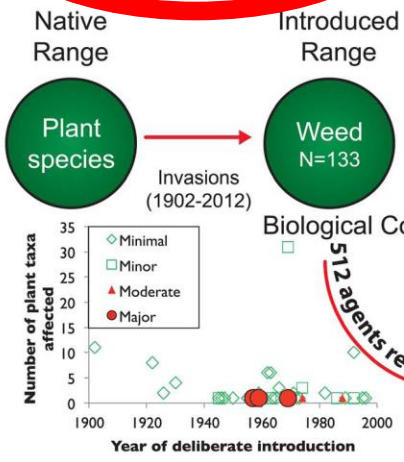

Realised Non-target Effects

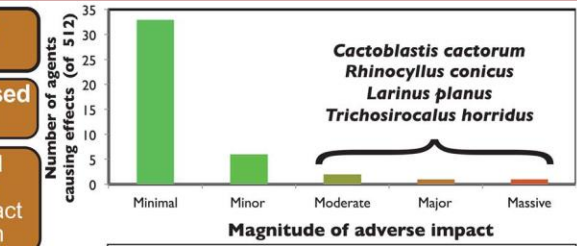

% of the 512 agents released with non-target impact

Magnitude	Percentage
Minimal	6.4%
Minor	1.2%
Moderate	0.4%
Major	0.2%
Massive	0.2%

Areas of Concern: Plant Reproduction Affected

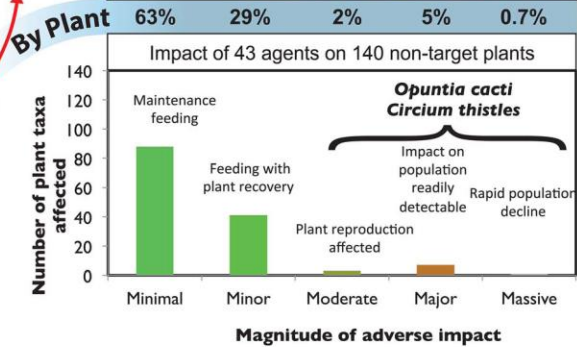

Probability of Beneficial Effects

No known non-target effects (91.2% of agents)

Benefit distribution across Minimal, Minor, Moderate, Major, Massive Weed Reduction Success (≥ Moderate) = 24% in New Zealand*

Risk of failure to establish self-sustaining populations, negligible benefit (36% in New Zealand)*



150 anni
 512 agenti
 133 weeds
 75 Paesi

Suckling & Sforza (2014), PLOS ONE, 9(1)

Controllo Biologico: Programma Time-Dependent

512 Agenti di Controllo Biologico

	Effects on individuals	Population dynamic effects	Community effects	Effects on ecosystem processes
Minimal	+	-	-	-
Minor	++	+	-	-
Moderate	+++	++	+	-
Major	++++	+++	++	+
Massive	+++++	++++	+++	++

61% establishment
32% control

Suckling & Sforza (2014), PLOS ONE, 9(1)

Roma, 14 aprile 2015

Convegno "Piano di azione nazionale per l'uso sostenibile dei prodotti fitosanitari: coordinamento, ricerca e innovazione"

Approccio Multidisciplinare oppure Processo Multitask ?

- ❖ Singola Pianta Infestante
(caso studio: *Ambrosia artemisiifolia*)

- ❖ (Agro)-Ecosistema da proteggere
(caso studio: **ECOVIA**)

Ambrosia artemisiifolia

- Specie annuale e monoica, ad impollinazione anemofila, produce grandi quantità di polline e semi;
- Originaria del nord America;
- Registrata per la prima volta in natura in Europa occidentale intorno al 1860;
- Diffusa dalla metà del XX secolo;
- Introdotta anche in Australia, Asia, Nuova Zelanda e Sud America.

Difficile da controllare: riscesce e fiorisce dopo trattamenti con erbicidi

<http://ragweed.eu>

Cortesia Dr. H. Mueller



INFESTANTI: Ambiente Antropico

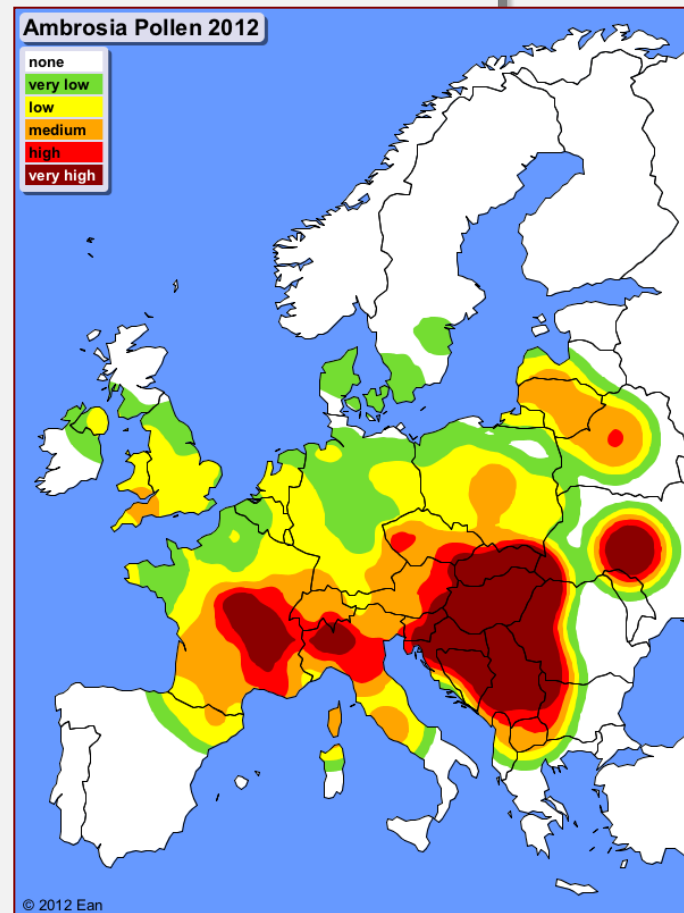

<http://ragweed.eu>

Cortesia Dr. H. Mueller

Candidati per il controllo biologico di tipo classico in Europa

Insetti

Ophraella communa
Epiblema strenuana

Pollen feeder



Col: *Trigonorhinus tomentosus*

Seed feeder

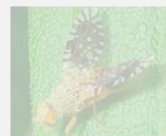

Dip: *Euaresia bella*

Funghi

Introduced range

Phyllachora ambrosiae
Plasmophora halstedii

Seed feeder



Col: *Smicronyx perpusillus*

Defoliator



Col.: *Zygogramma disrupta*

RU, China Defoliator



Lep: *Tarachidia candefacta*

Defoliator



Col: *Ophraella slobodkini*

Leaf pathogen



Bas: *Puccinia xanthii*



RU, China

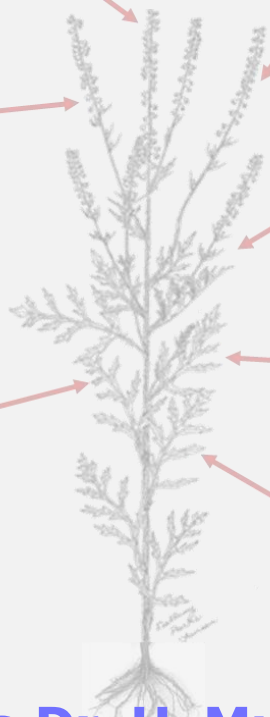

<http://ragweed.eu>

Cortesia Dr. H. Mueller

Roma, 14 aprile 2015

Convegno "Piano di azione nazionale per l'uso sostenibile dei prodotti fitosanitari: coordinamento, ricerca e innovazione"

L'arrivo di *Ophraella communa* in Europa



<http://ragweed.eu>

Cortesia Dr. H. Mueller



Ophraella communa



- Originaria USA/Mexico
- Allevamenti massali lanci di campo come agent di bio-controllo di *Ambrosia* in China
- Crescita ottimale a 25-30° C
- Multivoltina (1 mese/generazione)
- Adattabile a condizioni climatiche fredde

Cortesia Dr. H. Mueller

<http://ragweed.eu>

Roma, 14 aprile 2015

Convegno "Piano di azione nazionale per l'uso sostenibile dei prodotti fitosanitari: coordinamento, ricerca e innovazione"

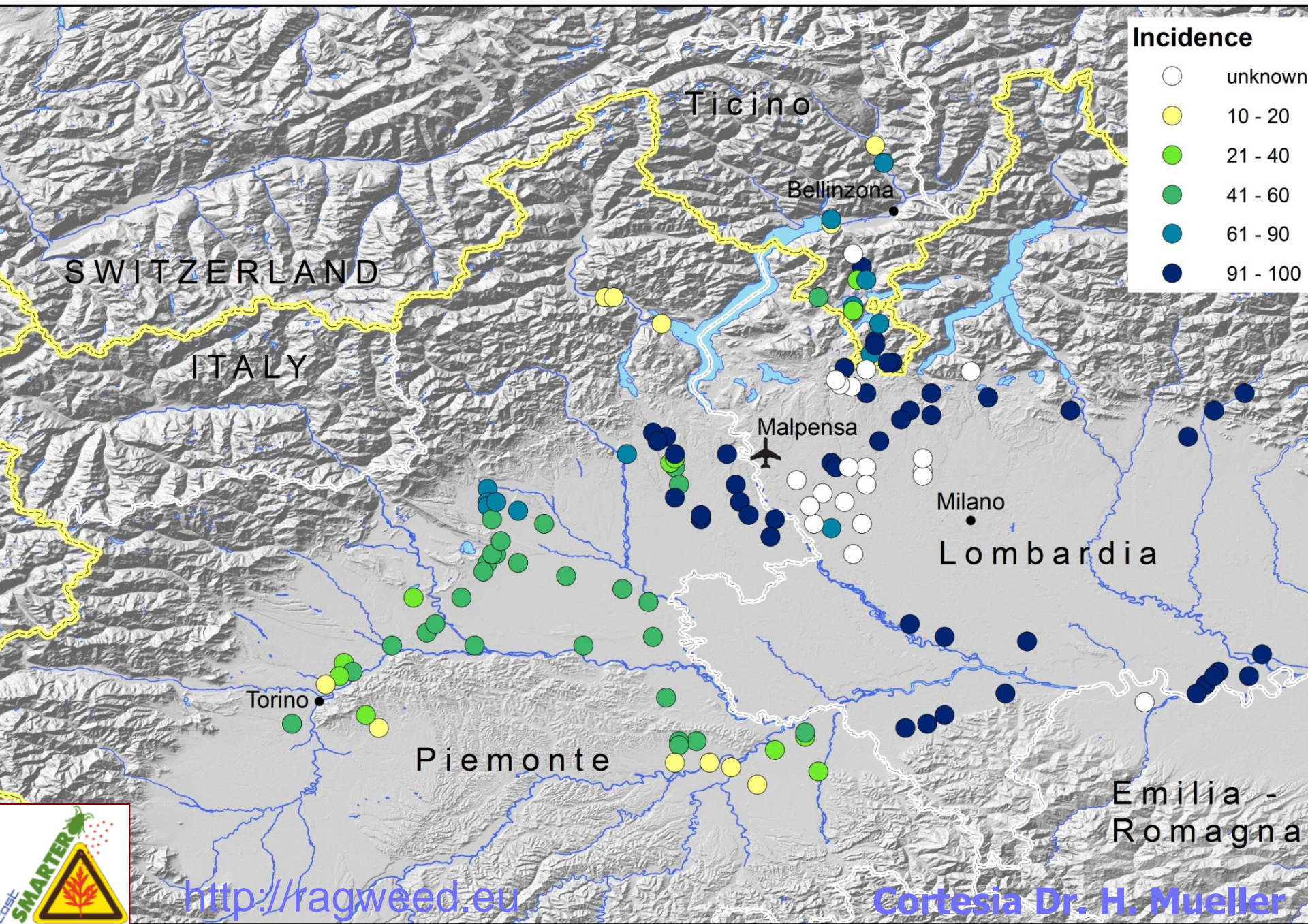

IWM: Multitask Process



❖ Comunità di Infestanti

IWM: Multitask Process



- ❖ Different Weed Species
(caso studio: **ECOVIA**)

Multitask Process



- ❖ Varie piante infestanti
(caso studio: **ECOVIA**)

IWM: Multitask Process

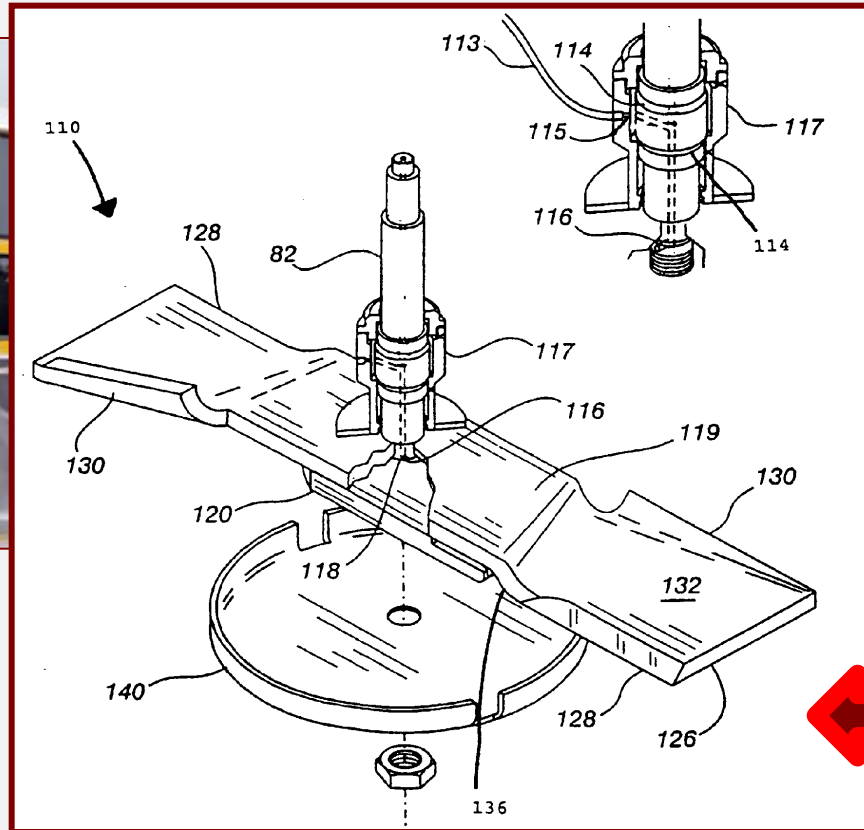

❖ Varie Piante Infestanti
(caso studio: **ECOVIA**)

Burch Wet Blade

Di Tomaso, pers. Comm.

Roma, 14 aprile 2015

Convegno "Piano di azione nazionale per l'uso sostenibile dei prodotti fitosanitari: coordinamento, ricerca e innovazione"

Substrato Fungino come Bio-Fabbrica di Fito-tossine: *Ascochyta caulina*

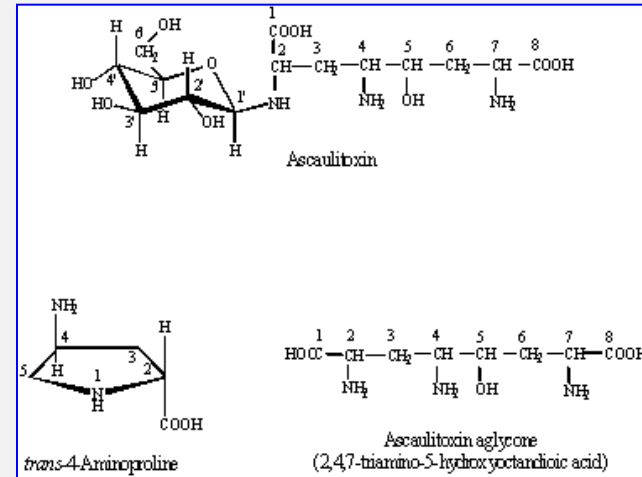

Materiali & Metodi

Test Plant Species

Species	Acronym
<i>Ambrosia artemisiifolia</i>	AMBEL
<i>Avena fatua</i>	AVEFA
<i>Chenopodium album</i>	CHEAL
<i>Convolvulus arvensis</i>	CONAR
<i>Oxalis acetosella</i>	OXAAC
<i>Parietaria officinalis</i>	PAIOF
<i>Poa annua</i>	POAAN
<i>Portulaca oleracea</i>	POROL
<i>Rubus fruticosus</i>	RUBFR
<i>Sorghum halepense</i>	SORHA
<i>Urtica dioica</i>	URTDI

Materiali e metodi: Laboratorio

▪ Spraying with phytotoxin solution

- Concentration 8 mg/ml
- Plant Phenology
 - A : 2-4 leaves
 - B : 5-8 leaves
- Quantity
 - A : 1 ml
 - B : 2 ml
- RH more than 90% for 24 h
- Checked daily for 7 dd

▪ Spraying with pure water (CTRL)



RISULTATI

Species	Acronym
<i>Ambrosia artemisiifolia</i>	AMBEL
<i>Avena fatua</i>	AVEFA
<i>Chenopodium album</i>	CHEAL
<i>Convolvulus arvensis</i>	CONAR
<i>Oxalis acetosella</i>	OXAAC
<i>Parietaria officinalis</i>	PAIOF
<i>Poa annua</i>	POAAN
<i>Portulaca oleracea</i>	POROL
<i>Rubus fruticosus</i>	RUBFR
<i>Sorghum halepense</i>	SORHA
<i>Urtica dioica</i>	URTDI



**100% di danno
sulla foglia**

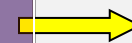

solo B-stage



solo A-stage

RISULTATI

Ambrosia artemisiifolia



Control –Stage A



Toxin-treated

Materiali e Metodi: **Campo**

▪ Spraying with phytotoxin solution

- Concentration 8 mg/ml
- Plant Phenology
 - A : 2-4 leaves
 - B : 5-8 leaves
- Quantity
 - A : 1 ml
 - B : 2 ml
- RH more than 90% for 24 h
- Checked daily for 7 dd



▪ Spraying with pure water (CTRL)

RISULTATI

Control (water)



Toxin-treated



Day 0

Day 7

Conclusioni:

Controllo Biologico e Integrato

1. Il controllo biologico va inteso come l'uso deliberato di organismi co-evoluti con la specie infestante da controllare
2. L'obiettivo del controllo biologico di tipo non è quindi l'eradicazione di una specie infestante ma il contenimento della sua densità di popolazione a un livello soglia più tollerabile.
1. Alcuni degli “aspetti positivi” del controllo biologico di tipo classico (la stretta specificità), il fatto di essere un processo a “lungo termine” (5-10 anni) e l'instabilità di moti modelli previsionali, vanno considerati come “limiting factors” (in particolare in ecosistemi antropizzati).
1. Una possibile alternativa è data dal controllo biologico/integrato di tipo “inondativo”, utilizzando patogeni e/o loro bio-prodotti con un approccio “Area-Wide” sia in termini spaziali che temporali.

GRAZIE
per
L'ATTENZIONE

mcristofaro@enea.it
silvia.arnone@enea.it
maurizio.vurro@ispa.cnr.it